

DOCAN POWER

PX300M BATTERY PACK SPECIFICATION



Product name:PX300M

Customer acknowledgment stamp		Company acknowledgment stamp		R & D department	
Department		Department		Version	V2.0
				Latest effective date	2025-02-15
				Editor	Jingyang Shao
				Reviewer	
Effective date		Effective date	2025-02-15	Approver	

Version Change History Form			
Version	Major Change History Description	Editor	Effective date
V1.0	Initial release	Jingyang Shao	2024-03- 22
V2.0	Appearance optimization	Jingyang Shao	2025-02- 15

Product acceptance and introduction

Proper use and maintenance of the product ensures long-term reliable and stable operation of your battery (or battery system) ,After receiving the product, please check whether the packaging is intact. If the packaging is damaged, the product may be damaged. If there is any damage, please contact our after- sales or sales staff within seven working days.

Anyone who fails to use or maintain it according to the provisions of this manual will be deemed to have waived the warranty right. We and its service station have the right not to provide warranty, and will not compensate for all losses arising therefrom, but can provide corresponding paid services according to the situation. Please reply within seven working days after your company receives the product and product manual. If there is no reply within seven working days, our company will treat the customer as acknowledging that this product and product manual meet your requirements.

1.3 Parameter

Product name	Project	Parameter	
Battery cell	Specifications and models	16pcs Lithium iron-300Ah	
	Nominal voltage	3.2 V	
	Nominal internal resistance	≤ 0.5 mΩ	
	Combination method	16 series 1 parallel	
	Matching criteria		Tolerance ≤ 1%
			Internal resistance range of single section ≤ 0.2 mΩ
			Single section voltage difference ≤ 5 mV
		Charge retention capacity ≥ 90%	
Finished product parameters	Nominal voltage (V)	51.2	
	Nominal Capacity (Ah)	300	
	Minimum Capacity (Ah)	300	
	Charge cut-off voltage (V)	58.4	
	Discharge cutoff voltage (V)	40	
	USB output voltage (V)	Without	
	USB Maximum Output Current (A)	Without	
	Maximum continuous discharge current (A)	200A	
	Display screen	Voltage and percentage display	
	Standard charging current (A)	Within 0.5C	
	Charge suitable for temperature	0°C~45°C	
	Discharge suitable temperature	-20°C~60°C	
	Battery pack size	871*729*300mm	
	Net weight of battery pack	118kg	
	Storage Temperature Range	0°C~40°C	
	Storage Ambient Humidity (RH)	<75%	
	Communication method	485,232,CAN,etc.	
Feature Options	Battery cell module active balancing 5A		
Charge retention capacity	After charging according to 3.2V standard charging, put it on hold for 28 days under standard test conditions, and then discharge according to 3.3V standard discharge, and the charge retention rate is ≥ 80%.		
Number of cycles	Cycle life not less than 6000 times, capacity retention rate ≥80%. (Charge according to 3.2V standard charging and shelve for 0.5 to 1 hour ; discharge according to 3.3V standard discharge and shelve for 0.5 to 1 hour, counting one cycle).		
Management System	Single overvoltage protection value	3.7 V	
	Over pressure release value	3.65 V	
	Single undervoltage protection value	2.5 V	
	Under voltage release value	2.7 V	
	Over current protection value	300A	

01.Product indicators

1.1 Product Overview

This product is a lithium iron battery pack. The battery pack consists of 16pcs 3.2V 300Ah lithium iron phosphate cells through 16 series and 1 parallel modes Combined. The battery pack adopts scientific internal structure design and advanced battery production technology. It has the characteristics of high specific energy and long life, safety and reliability, and wide operating temperature range. It is a green energy storage power supply product.

1.2 Pictures

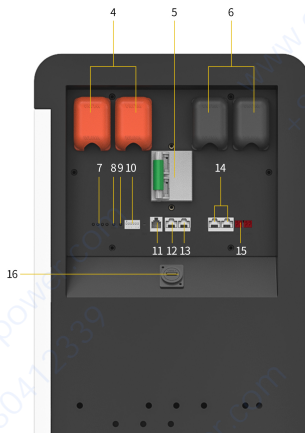

- 1. Touchscreen
- 2. Power switch
- 3. handle
- 4. positive terminal(+)
- 5. DC breaker
- 6. negative terminal(-)
- 7. SOC light
- 8. ALM light
- 9. RUN light
- 10. DIP address
- 11. RS232
- 12. RS485
- 13. CAN
- 14. RS485 A B
- 15. Dry contact
- 16. WIFI module interface

02.BMS

Positive product physical picture



Reverse product physical picture



Switch communication board physical positive and negative picture



03. Functiondescription

3.1 Voltage detection and protection function

It has the functions of overvoltage, low voltage alarm and overvoltage and undervoltage protection for single cell and battery pack.

3.2 Current detection and protection function)

It has the functions of charge and discharge current detection, alarm and protection. The upper computer displays negative current for discharge and positive current for charging.

3.3 Short-circuit protection function

It has the function of detection and protection of output short circuit.

3.4 Temperature detection function

With cell, environment, power MOS temperature detection, and can be charged and discharged in high temperature, low temperature alarm and protection. There are 4 channels of cell temperature detection, 1 channel of ambient temperature detection, 1 channel of power MOS temperature detector detection, and a total of 6 channels of NTCS.

3.5 Temperature detection function

The battery SOC can be calculated in real time. The full capacity and current capacity of the battery pack can be set by the upper computer for a complete charging and discharging cycle, and the postcycle capacity can be automatically configured. It has the function of calculating the number of charge and discharge cycles. When the cumulative discharge capacity of the battery pack reaches more than 80%, the number of cycles is increased once.

3.6 Charge/discharge MOSFET switch function

Low internal resistance, high current, for the backup power supply application of large capacity load boot, zero switching, high charging voltage resistance optimization design.

3.7 Battery charging balancing function

The charging balancing policy can be flexibly set (starting voltage and balancing voltage), which can effectively improve the battery life and cycle life.

3.8 LED status indicator function

It has 6 LED indicators, 4 remaining battery capacity indicators, 1 running indicator and 1 alarm protection status indicator.

3.9 Key switch function

One-button switch design, the system can be manually started when the shutdown state, when the standby state can be manually shut down.

3.10 RS485 and CAN communication functions

With RS485, CAN communication function, can realize the PC or intelligent front end through telemetry, remote communication, remote control, remote control and other commands to achieve battery data monitoring, operation control and parameter setting, to real-time monitoring BMS and battery pack status.

3.11 Upper computer control function

It can set various battery management parameters such as over and under voltage of single battery, over and under voltage of total battery, over current of charge, over current of discharge, over current of discharge, high and low temperature of battery cell, high and low temperature of environment, balancing strategy, number of battery series, and battery capacity. It can open and close discharge MOS, charge MOS, current limiting function switch, and buzzer alarm switch. Forced sleep switch and realize the system software online upgrade function.

3.12 Hardware voltage detection function

BMS design is equipped with unique hardware detection protection circuit. Ensure that the BMS can run safely and reliably for a long time under abnormal conditions.

3.13 Historical data storage function

The storage capacity of historical records is not less than 500 records, facilitating system monitoring, analysis, and maintenance.

3.14 Parallel communication function







It can realize the function of parallel communication through RS485 interface, with dip switch, which is used to set the address in parallel communication.

3.15 Charging current limiting function

It has 10A current limiting function. The current limiting mode includes passive current limiting mode and active current limiting mode. The default passive current limiting mode of this product is passive current limiting. Charging current greater than 110A start current limit.

3.16 LED indicator definition

LED lights: 4 green capacity indicators, one red alarm indicator, and one green running indicator

SOC 1	SOC 2	SOC 3	SOC 4				
							
SOC						ALM	RUN

State	Charge				Discharge			
Capacity indicato	SOC 4	SOC 3	SOC 2	SOC 1	SOC 4	SOC 3	SOC 2	SOC 1
0~25%	Blink2	OFF	OFF	OFF	ON	OFF	OFF	OFF
25~50%	OFF	Blink2	OFF	OFF	ON	ON	OFF	OFF
50~75%	OFF	OFF	Blink 2	OFF	ON	ON	ON	OFF
75~100%	OFF	OFF	OFF	Blink2	ON	ON	ON	ON
Running indicator light	Stady light				Blink 3 tims			

3.17 RS485 communication

BMS can communicate with the upper computer through the RS485 communication interface, through the upper computer to view various information of the battery, such as voltage, current, temperature, SOC, SOH, working state, battery production information and can be set parameters.

The RS485 parallel port supports a maximum of 16 battery strings simultaneously. The default baudrate is 9600bps.

With upper computer/inverter communication RS485 interface, the default baud rate is 9600bps;

3.18 CAN communication

The BMS CAN communicate with the inverter through the CAN interface, and upload various information of the battery, such as voltage, current, temperature, SOC, SOH, working status, and battery production. The default baud rate is 500Kbps.

3.19 Bluetooth APP



Android



IOS

04. Communication interface definition

4.1 Interface diagram

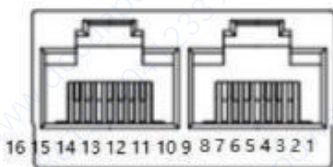

RS485

CAN

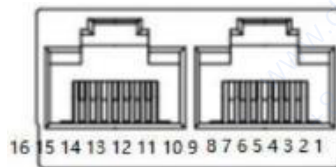

RS485A

RS485B

4.2 BMS interface definition

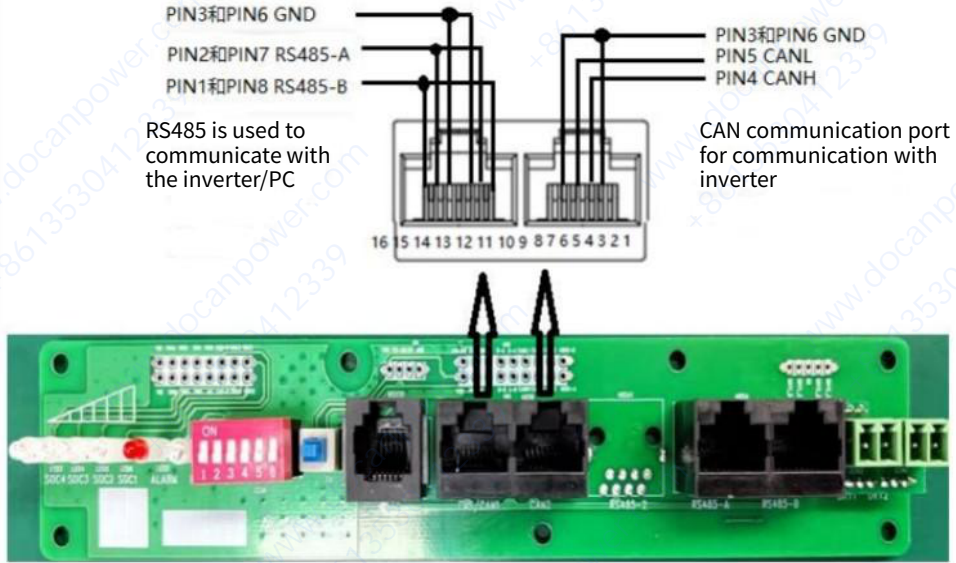

4.3 Communication interface definition

Rs485 interface (communication with host computer or inverter) Support for SRNE、Voltronic and Geowatt inverter protocol--Select different addresses using DIP switches		CAN communication interface (only inverter communication) Support for Victron、Pylon and Geowatt inverter protocol--Use DIP switches to select different protocols	
RS485—Use 8P8C vertical RJ45 socket		CAN—Use 8P8C vertical RJ45 socket	
RJ45 pin	defined declaration	RJ45 pin	defined declaration
9、16	RS485A-B	4	CANH
10、15	RS485A-A	5	CANL
11、14	GND	3、6	GND
12、13	NC	1、2、7、8	NC

Parallel communication port (for parallel only)			
RS485-A—Use 8P8C vertical RJ45 socket		RS485-B—Use 8P8C vertical RJ45 socket	
RJ45 pin	defined declaration	Rj45 pin	defined declaration
9,16	RS485A-B	4	CANH
10、15	RS485A-A	5	CANL
11、14	GND	3、6	GND
12、13	NC	1.2、7、8	NC

4.4 BMS board parallel connection mode

The batteries are connected to each other using standard network cables.

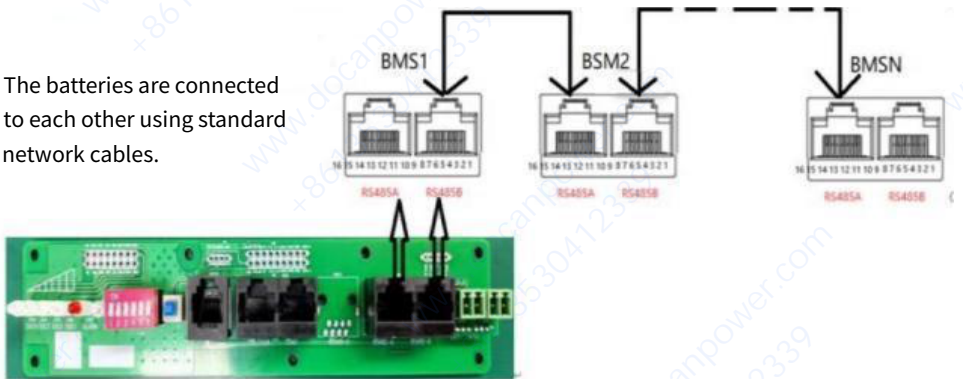



















4.5 Dip switch setup (supports parallel and protocol selection)

When battery strings are connected in parallel, the hardware DIP address of each PACK is unique. The hardware address is set by the DIP switch on the board. See the following table.



Address	Dip switch position				Reserved	Host	Declaration
	#1	#2	#3	#4			
0	OFF	OFF	OFF	OFF	OFF	OFF	Pack1
1	ON	OFF	OFF	OFF	OFF	OFF	Pack2
2	OFF	ON	OFF	OFF	OFF	OFF	Pack3
3	ON	ON	OFF	OFF	OFF	OFF	Pack4
4	OFF	OFF	ON	OFF	OFF	OFF	Pack5
5	ON	OFF	ON	OFF	OFF	OFF	Pack6
6	OFF	ON	ON	OFF	OFF	OFF	Pack7
7	ON	ON	ON	OFF	OFF	OFF	Pack8
8	OFF	OFF	OFF	ON	OFF	OFF	Pack9
9	ON	OFF	OFF	ON	OFF	OFF	Pack10
10	OFF	ON	OFF	ON	OFF	OFF	Pack11
11	ON	ON	OFF	ON	OFF	OFF	Pack12
12	OFF	OFF	ON	ON	OFF	OFF	Pack13
13	ON	OFF	ON	ON	OFF	OFF	Pack14
14	OFF	ON	ON	ON	OFF	OFF	Pack15
15	ON	ON	ON	ON	OFF	OFF	Pack16
Inverter communication protocol Select CAN communication (select by DIP 5 and 6 in host mode)							
1	OFF	OFF	OFF	OFF	OFF	OFF	Supports host computer/display Select the inverter protocol
17	OFF	OFF	OFF	OFF	ON	OFF	Victron
33	OFF	OFF	OFF	OFF	OFF	ON	Pylon
49	OFF	OFF	OFF	OFF	ON	ON	Geowatt
Inverter communication protocol RS485 communication (Select DIP 5 and 6 in host mode)							
1	OFF	OFF	OFF	OFF	OFF	OFF	Supports host computer/display Select the inverter protocol
17	OFF	OFF	OFF	OFF	ON	OFF	SRNE
33	OFF	OFF	OFF	OFF	OFF	ON	Voltronic
49	OFF	OFF	OFF	OFF	ON	ON	Geowatt

4.6 Inverter pins definition

Inverter manufacturer	Communication mode	BMS DIP switch mode of the host	Inverter interface definition	Use standard network cables
Growatt-SPF	CAN		4H,5L	OK
Growatt-SPF	485		1B,2A	OK
Growatt-SPH	CAN		4H,5L	OK
Goodwe	CAN		4H,5L	OK
Solis	CAN		4H,5L	OK
Sofar	CAN		1H,2L	Customized network cable
SMA	CAN		4H,5L	OK
Victron	CAN		7H,8L	Customized network cable
Luxpower	CAN		4H,3L	Customized network cable
Deye	CAN		4H,5L	OK
Sorotec	CAN		4H,5L	OK
Megarevo	CAN		4H,5L	OK
Voltronic	485		3B,5A	Customized network cable
SRNE	485		7A,8B	Customized network cable
senergy	CAN		4H,5L	OK
Sol-Ark	CAN		4H,5L	OK
MPP Sola	485		3B,5A	Customized network cable
Sacolar	CAN		4H,5L	OK
TRONTE	485		3B,5A	Customized network cable

4.7 Real-time monitoring interface(PC):

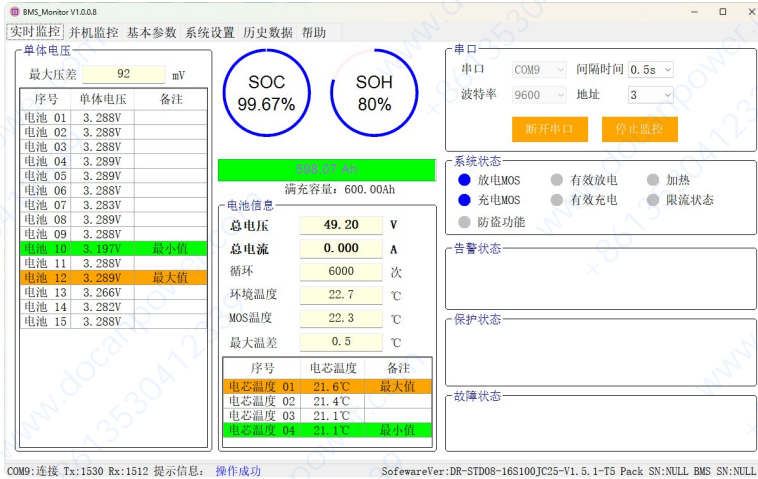

4.8 Touch screen

Screen shows the current status of the battery, including voltage, SOC, temperature, operating current, number of charge-discharge cycles, as well as the status of the battery cells.



05. How to use the battery pack

5.1 Charging

The charging terminal of the battery pack is connected to the suitable charger (the charging voltage is 58.4 V, do not connect it reversely) for charging.

5.2 Discharge

Pay attention to the positive and negative poles (as shown in the battery case logo, do not connect them reversely) and connect them to the matching load.

5.3 Battery pack test

The parameters of single battery and protection circuit are only standard test data when used as separate accessories and are for reference only.

5.4 Battery Pack Test Requirements

The tested battery pack has left the factory for no more than one month. If it is not tested due to other reasons such as transportation, the battery pack can be charged and discharged again and then tested.

All tests in this specification should be carried out under standard atmospheric conditions : temperature : 15-26 °C ; Relative humidity : $65 \pm 20\%$.

The standard charging voltage of the battery pack is 58.4 V, the standard discharge cut-off voltage is about 40V, and the standard current is 0.2 C.

5.5 Standard charging

Use a special test cabinet for lithium-ion battery pack to charge with standard charging voltage, standard current, constant current and constant voltage until the current drops to 0.05 A.

5.6 Standard discharge

Use a special test cabinet for lithium-ion battery pack to discharge at standard current and constant current until the standard discharge cut-off voltage or the battery pack cut-off.

06.Warnings

- (1) Do not use the battery if it has been impacted or if there is noticeable deformation.
- (2) Do not stack or assemble the batteries improperly. Please pay attention to the battery polarity and the connection terminals.
- (3) Insulate equipment properly and use tools and instruments correctly.
- (4) The battery installation area should be kept away from fire sources or any combustible materials. Ensure adequate ventilation and that the area is dry.
- (5) Plugging in kits while the product is operating is strictly prohibited.
- (6) Do not support series connection. Series connection will cause irreversible damage to the batteries.
- (7) Please fully charge the battery with the specified charger before using new batteries or after long periods of storage.
- (8) Do not disassemble, open, squeeze, bend, deform, pierce, or damage the product.
- (9) Do not attempt to modify or insert any external objects into the product. Avoid exposing the product to liquids such as saltwater, freshwater, or beverages (e.g., coffee, juice, etc.). Keep it away from fire sources, explosive materials, or other hazards.
- (10) Do not short circuit the battery. Ensure the battery terminals do not come into contact with metal or other conductive materials.
- (11) Do not drop the battery. If this occurs (especially if it hits a hard surface), please contact the service center immediately.
- (12) If there is any electrolyte leakage, avoid contact with skin or eyes. If contact occurs, rinse the affected area thoroughly with clean water and seek medical attention.
- (13) Do not disassemble the cell battery under any circumstances. This may cause an internal short circuit, fire, or other hazards.

(14) Do not burn or expose the battery to fire under any circumstances. Doing so may cause the battery to catch fire.

(15) When connecting multiple battery packs in parallel, if your load exceeds 200A, use multiple terminals for parallel output. The chassis terminals cannot withstand currents exceeding 200A. Prolonged use of high current is not recommended, as it may cause the cables and terminals to overheat.

07. Other technical indicators

For any matters not covered in this manual and other related parameters, please contact our sales or technical staff if you need assistance. We will provide as much information as possible. Thank you for your understanding. You are welcome to visit our company website or call our customer service hotline at any time for more product information.

08.Special Statement (Users Need to Know)

Before purchasing and using the product, users should be aware of the special nature of lithium battery products and the risks associated with improper use. It is essential to read this product manual carefully and to have individuals with the necessary technical skills and knowledge operate the product. The technical performance, safety performance, and quality standards indicated for this product apply only when users meet the technical, environmental, and skill requirements and follow the correct operating procedures.

Improper use, including incorrect methods, faulty connections, inappropriate power adapters, or load parameters that do not comply with the performance specifications indicated in this manual, may cause damage to the product and jeopardize the safety of users and their property. Any product damage or other losses resulting from improper use by the user do not fall under product quality issues, and the company will not assume any related responsibilities. Our R&D center will continuously improve and upgrade the product in terms of technology, performance, and operation. Users are encouraged to regularly check our company website or contact our sales engineers for the latest product information.

This product must comply with the following management standards and conditions (not limited to) for usage, storage, and application:

This product is strictly prohibited from being used for any purpose that violates the laws and regulations of the local country. This product is strictly prohibited from being used in areas that violate the environmental and location requirements for lithium batteries.

This product must not be used, charged, or stored in residential buildings or crowded areas that are fire safety risk zones.

This product must not be used, charged, or stored beyond the prescribed technical standards.

This product must not be disassembled, modified, or integrated in any unauthorized manner.

This product should not be stored together with any flammable or explosive materials or other similar products in violation of regulations.

//////DOCAN POWER

CONTACT ME

info@docanpower.com